

THE KING'S GATE®

PROTECTING YOUR DOMAIN



Ercole®

IL BELLO
DELLA
SICUREZZA



Provided Exclusively by

SAFE AND SOUND



THE KING'S GATE®

The Kings Gate®
is an exclusive custom fabricated high
security door designed specifically to
protect your domain.

Choose **your finishes** and **technology**
to personalize your entrance

LOCKING POINTS

HIGH SECURITY MULTI POINT LOCKING SYSTEM

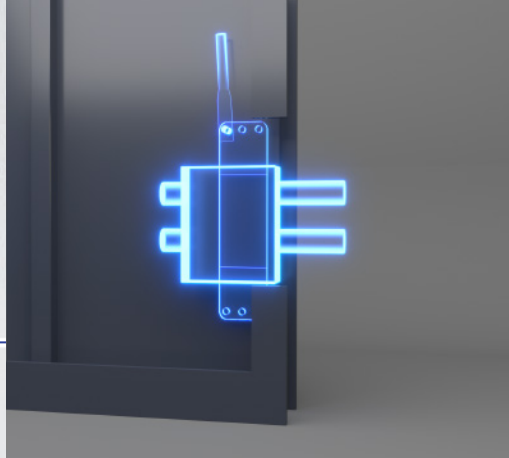
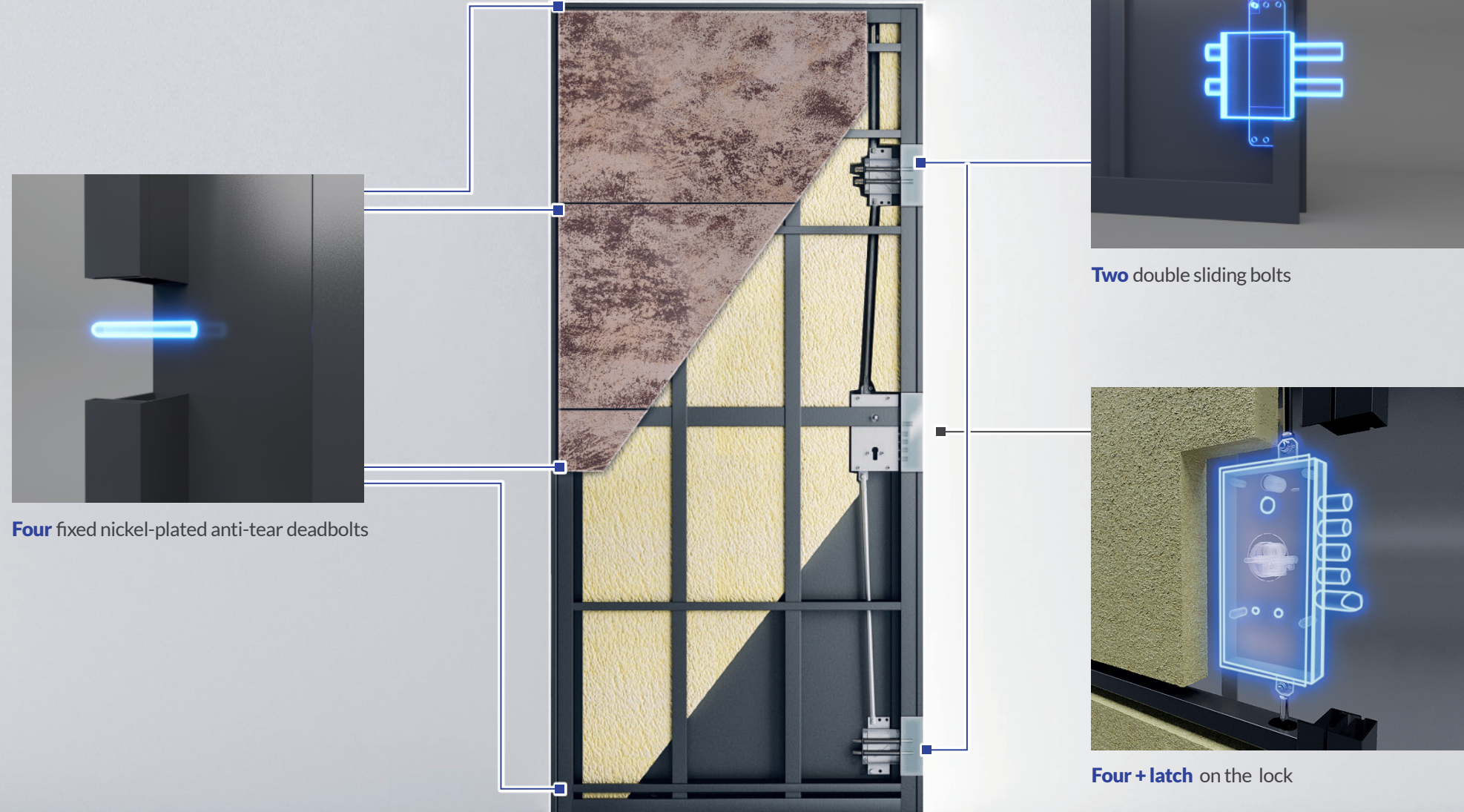

Two double sliding bolts

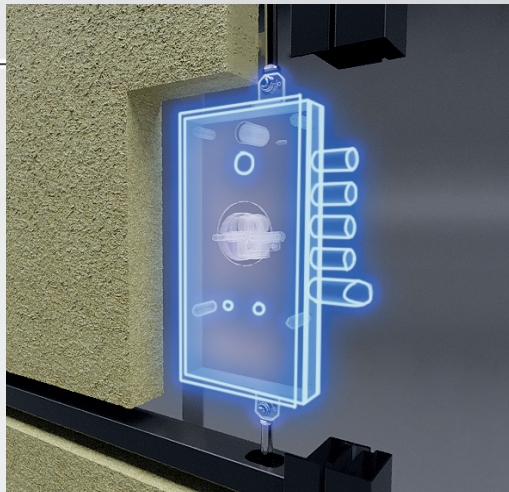

Four + latch on the lock

STANDARD FEATURES



- ✓ High grade steel frame armored steel door
- ✓ Draught closer
- ✓ Motorized lock
- ✓ Concealed hinges

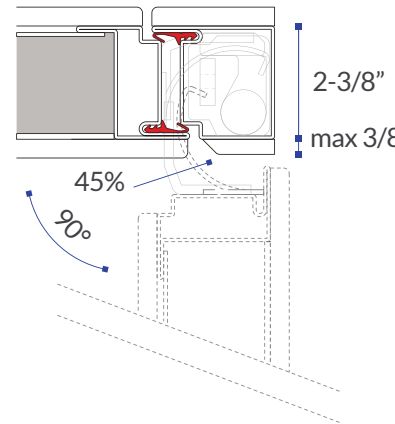

1-1/2" thick pressed rockwool layer

Double gaskets on frame and leaf

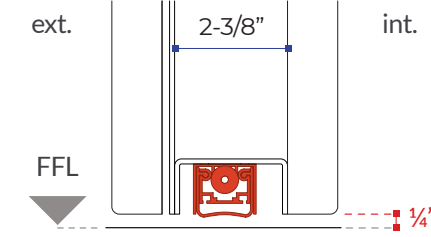

Floor solution with draft closer

BALLISTIC LEVEL

LEVEL	WEAPON TYPE	CALIBER	SHOTS
1		9 mm	3

TECHNOLOGY



- Motorized lock
- Access through proximity sensor (hidden or visible)
- Master and service transponder option
- Optional battery-power

DOOR SIZES

WIDTH - 32", 34", 36" HEIGHT - 80", 84", 90", 96"

CLADDING OPTIONS

BACK PAINTED GLASS



White RAL9010



Black RAL 9005



Red RAL 6009

LEATHER



White RAL9010

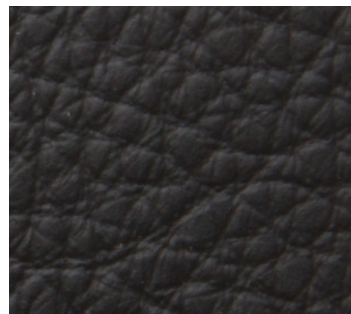

Black RAL 9005

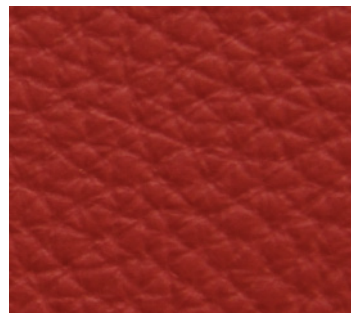

Red RAL 6009

PAINTED WOOD



White RAL9010



Black RAL 9005



Red RAL 6009



MIX COLORS & MATERIALS



HARDWARE

LEVERS

H13

5-3/4"

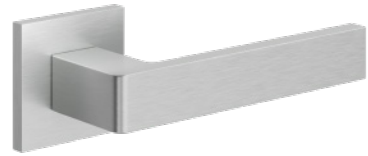

H6

5-2/3"

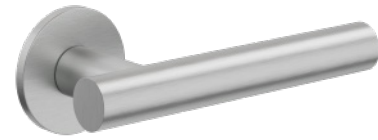

PULL BARS

P0

12-7/8"
CTC: 11-3/4"

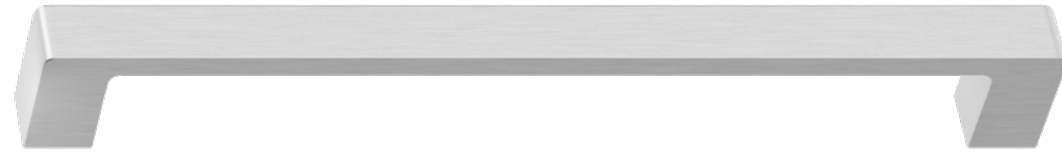

P6

18-1/8"
CTC: 11-3/4"



AVAILABLE FINISHES



Polished chrome



Satin brass

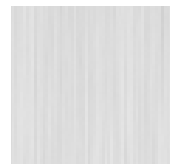

Satin chrome





Matt black

TRIM



CHOOSE YOUR WOOD TRIM COLOR TO ENHANCE PERSONALITY.



OPTIONAL

BALLISTIC LEVEL	Weapon type	Caliber	Shots
LEVEL 3		0.44 ReM. Magnum	3 of 240 grains
LEVEL 5		7.62 mm x 39	1 of 150 grains
LEVEL 8		7.62 x 51	5 of 150 grains

HI-TECH

 KEYPAD	 BIOMETRIC	 FACIAL RECOGNITION
Motorized lock	Motorized lock	Motorized lock
Access through an alphanumeric keypad	Fingerprint scanner system	Audio-video VOIP intercom
	Master and service fingerprint (option)	3D face recognition system
		Access through a touch screen keypad or RFID-card
		Direct power connection only

OPTIONAL

CTC (Concealed tactical compartment)

- ✔ Secret mini safe included in your armored door
- ✔ Possibilities to open it manually (button on the edge of the door) and through any added technology device (see hi-tech section)
- ✔ Ideal to hide jewelry, small weapons, watches or money
- ✔ Max 2" deep
- ✔ Illumination via LED at the top of the compartment

Note CTC requires horizontal and vertical reveals and is best hidden in dark skins

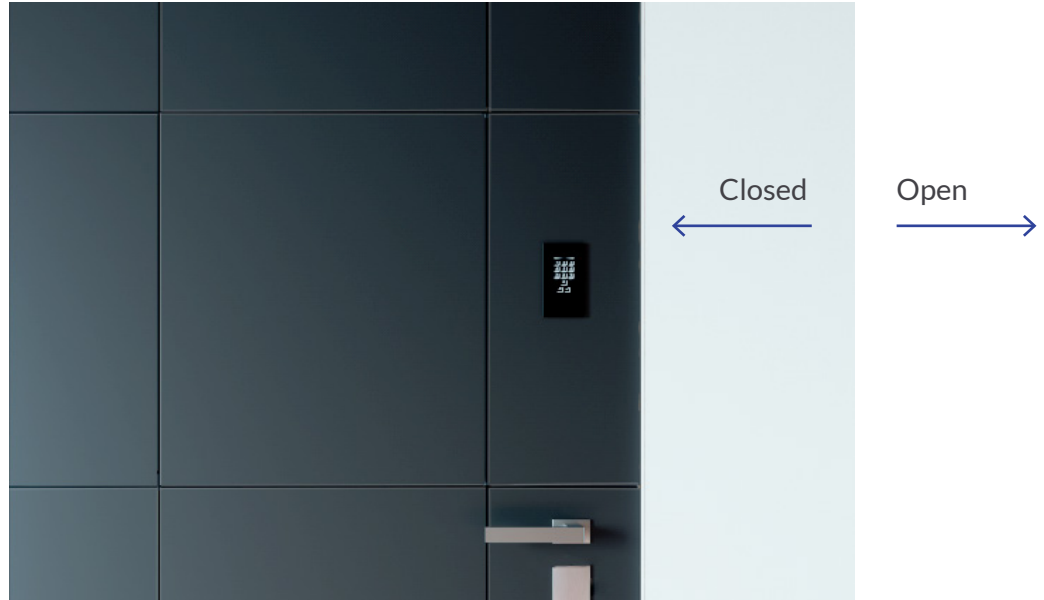



ERCOLESICUREZZA.COM



Safe and sound Inc.

SAFEINFLORIDA.COM

T. (239) 289-1555

E. office@SafeInFlorida.com

SHOWROOM

2900 Tamiami Trail N
Naples FL 34103 USA

WAREHOUSE-OFFICES

4795 Mercantile Avenue Suite 1
Naples FL 34104 USA